



Mix'n Machine®

ALL MODELS

Use and Care Manual

Read and save these instructions

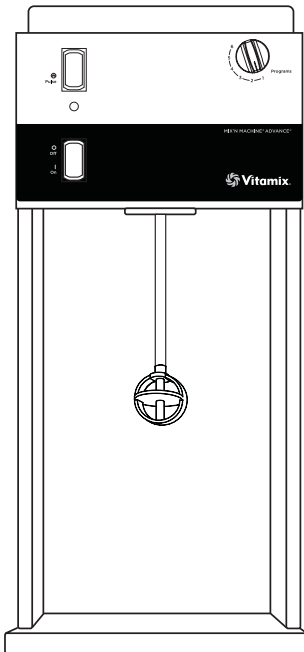

MIX'N MACHINE® ADVANCE®

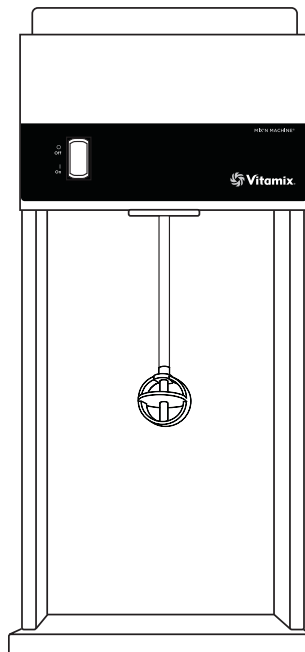

MIX'N MACHINE®

IMPORTANT SAFEGUARDS

1. **Read all instructions.**
2. To protect against risk of electrical shock, do not put motor enclosure in water or other liquid.
3. Close adult supervision is necessary when machine is used by or near children. Children should be supervised to ensure that they do not play with the appliance. This appliance is not intended for use by persons (including children) with reduced physical, sensory or mental capabilities, or lack of experience and knowledge, unless they have been given supervision or instruction concerning use of the appliance by a person responsible for their safety.
4. Make sure the machine is sitting or mounted solidly on a sturdy surface or wall before using.
5. Unplug the power cord from the wall outlet when the Vitamix machine is not in use, before disassembling, putting on or taking off parts, and before cleaning, other than washing the agitator.
6. Never contact moving parts.
7. Do not operate any machine with a damaged cord or plug, if the machine malfunctions, or has been dropped or damaged in any manner. In the US and Canada, call Vitamix Technical Support, (800) 866.5235 at once for examination, repair, possible replacement, or electrical or mechanical adjustment. If you live outside the United States or Canada, contact your local Vitamix Distributor, or telephone the Vitamix International Division at +1 (440) 782.2450 or email international@vitamix.com for a distributor in your country.
8. Do not use attachments not recommended or sold by Vita-Mix Corporation. Doing so will void the warranty. ALTERATION OR MODIFICATION OF THIS PRODUCT IN ANY FORM IS NOT SUPPORTED AND AS SUCH MAY RESULT IN BODILY INJURY.
9. **Do not use outdoors.**
10. Do not let the power cord hang over edge of table or counter.
11. Do not place the machine on or near a hot gas or electrical burner, in a heated oven, or allow machine to touch hot surfaces. External heat sources can damage the machine.
12. Keep hands, utensils and other items away from the agitator while motor is running to prevent the possibility of severe personal injury and/or damage to the Vitamix machine.
13. Always keep splash guard in place while running.
14. When using the optional foot pedal control (for applicable models) make sure it is grounded and located where it will not be activated unintentionally. When the machine is not in use, turn OFF the power switch so the unit cannot accidentally be started with the foot pedal.
15. **CAUTION:** For applicable models, the light in the front panel start/stop switch, when lit, indicates the power is ON and machine could start. Turn power OFF or unplug the machine before touching movable parts. Shut OFF power switch at night or whenever machine will be left unattended.

Save These Safety Instructions

- The Vitamix blender's U.S.A. power cord comes equipped with a three-prong (grounding) plug which mates with a standard three-prong wall outlet (Figure A). **This cord will vary for countries outside the United States of America.**
- Adapters (Figure B) are available for two-prong outlets. Do not cut or remove the third (ground) prong from the plug or power cord.
- Consult your electrician if you are not sure if the wall outlet is grounded through the building wiring. With a properly grounded two-prong wall outlet, ground the machine by attaching the tab on the adapter to the wall outlet cover by means of the screw in the center of the cover (Figure B).



WARNINGS!

Three-prong adapters are not to be used in Canada.

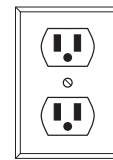

FIGURE A

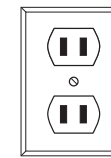

FIGURE B

IMPORTANT NOTES!

The instructions appearing in this Use and Care Manual cannot cover every possible condition and situation that may occur. Common sense and caution must be practiced when operating and maintaining any appliance.

CONTROL PANEL

IMPORTANT NOTES!

Vitamix machines come with several different control options. Please be sure you are following the instructions for your model.

MOUNTING KITS: Mounting Kits, with detailed instructions, are available for both the countertop and wall mount Mix'n Machines. See Parts Lists on page 17 and 19 for kit details.

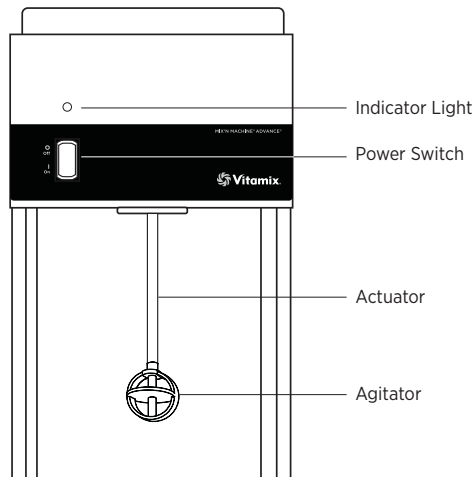

Mix'n Machine Advance Timer Model

Pre-programmed with one pre-set blending cycle.

COUNTERTOP

ON/OFF Power Switch: This is a lighted switch. When light is lit, power is ON. Located on the front of the machine, the ON/OFF switch controls the power to the machine. While plugged in, switch to ON to ready the machine for blending. Shut OFF the power switch at night or whenever the machine will be left unattended.

START Actuator: The actuator starts the agitator and begins a pre-set timed blending cycle when the machine is ON. Push the actuator to activate a timed blending cycle. The machine will shut off automatically at the end of the pre-set time. **AGITATOR.** When the machine is turned ON and the actuator is pushed, the agitator spins and mixes the product and other ingredients. (See page 12 for available agitators.)

LED Indicator Light: The LED light blinks when a blending program is 4 seconds from completion so that excess product can be spun off the agitator. The blinking light will get progressively faster to indicate that the program cycle is almost complete. When a new program is installed using a programming chip, the light blinks to indicate acceptance.

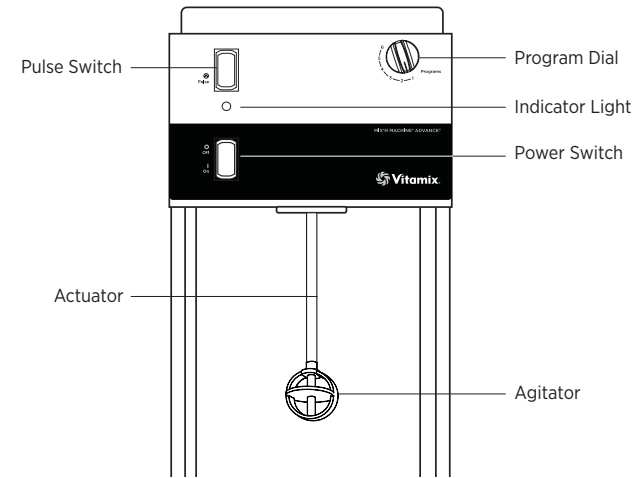

Mix'n Machine Advance Programmable Model

Pre-programmed with six blending options and pulse switch.

COUNTERTOP

ON/OFF Power Switch: This is a lighted switch. When light is lit, power is ON. Located on the front of the machine, the ON/OFF switch controls the power to the machine. While plugged in, switch to ON to ready the machine for blending. Shut OFF the power switch at night or whenever the machine will be left unattended.

START Actuator: The actuator starts the agitator and begins a blending cycle when the machine is ON. Push the actuator to activate a program setting. The machine will shut off automatically at the end of the program setting.

AGITATOR: When the machine is turned ON and the actuator is pushed, the agitator spins and mixes the product and other ingredients. (See page 12 for available agitators.)

PROGRAM Dial: The PROGRAM dial allows user to select a number of pre-programmed settings. Machine will shut off automatically at the end of the program. Program is activated only when the power switch is ON. See page 10 for programming details.

PULSE Switch: The PULSE switch starts the agitator and can be used to quickly refresh product. Depress the switch and hold down as long as needed. The PULSE switch can only be used when the power switch is ON.

LED Indicator Light: The LED light blinks when a blending program is 4 seconds from completion so that excess product can be spun off the agitator. The blinking light will get progressively faster to indicate that the program cycle is almost complete. When a new program is installed using a programming chip, the light blinks to indicate acceptance.

CONTROL PANEL

IMPORTANT NOTES!

Vitamix machines come with several different control options. Please be sure you are following the instructions for your model.

MOUNTING KITS: Mounting Kits, with detailed instructions, are available for both the countertop and wall mount Mix'n Machines. See Parts Lists on page 17 and 19 for kit details.

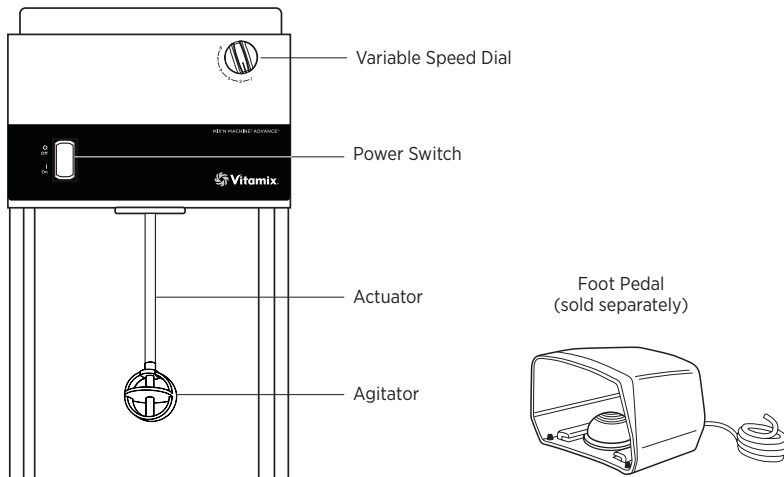

Mix'n Machine Advance Variable Speed Model

COUNTERTOP

ON/OFF Power Switch: Located on the front of the machine, the ON/OFF switch controls the power to the machine and starts the agitator. While plugged in, switch to ON to start blending and OFF to stop blending.

AGITATOR: When the machine is turned ON, the agitator spins and mixes the product and other ingredients. (See page 12 for available agitators.)

VARIABLE SPEED Dial: The VARIABLE SPEED dial allows user to select continuously variable motor speeds. Dial is activated only when the power switch is ON.

FOOT PEDAL Control (sold separately): The FOOT PEDAL allows the user hands free power activation. Press and hold for ON. Release for OFF. (Refer to the Foot Pedal's Instructions sheet, which is included with the pedal, for detailed operating directions.) Place the foot pedal where it will not be activated unintentionally. The foot guard is an additional design feature that helps prevent unintentional use of the foot pedal.

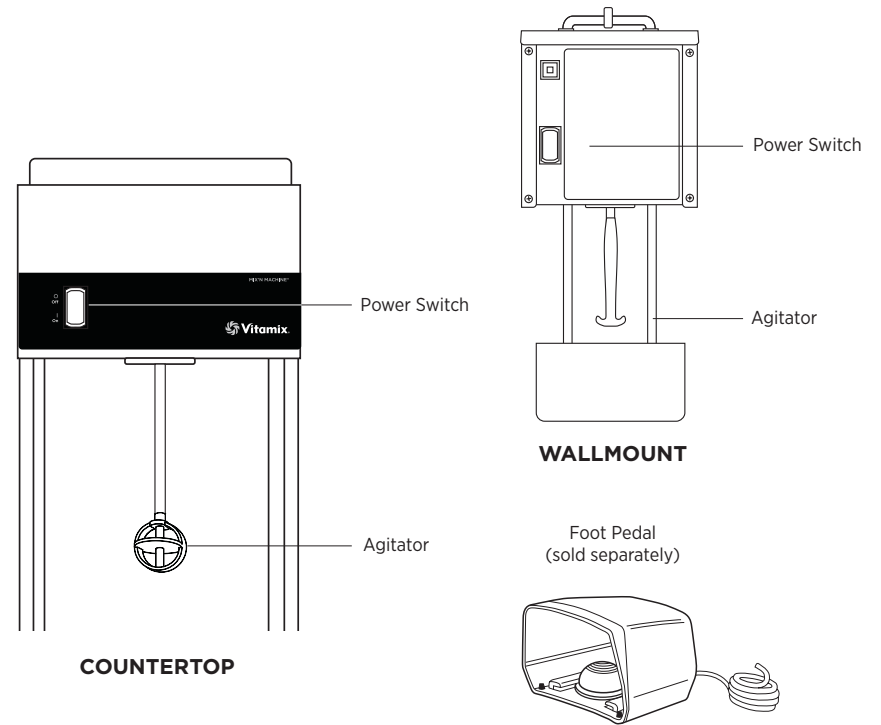

COUNTERTOP

Mix'n Machine Standard Model

COUNTERTOP

ON/OFF Power Switch: Located on the front of the machine, the ON/OFF switch controls the power to the machine and starts the agitator. While plugged in, switch to ON to start blending and OFF to stop blending.

AGITATOR: When the machine is turned ON, the agitator spins and mixes the product and other ingredients. (See page 12 for available agitators.)

WALLMOUNT

ON/OFF Power Switch: Located on the front of the machine, the ON/OFF switch controls the power to the machine and starts the agitator. While plugged in, switch to ON to start blending and OFF to stop blending.

AGITATOR: When the machine is turned ON, the agitator spins and mixes the product and other ingredients. (See page 12 for available agitators.)

FOOT PEDAL Control (sold separately): The FOOT PEDAL allows the user hands free power activation. Press and hold for ON. Release for OFF. (Refer to the Foot Pedal's Instructions sheet, which is included with the pedal, for detailed operating directions.) Place the foot pedal where it will not be activated unintentionally. The foot guard is an additional design feature that helps prevent unintentional use of the foot pedal.

GENERAL INSTRUCTIONS

The Mix'n Machine combines a durable motor with different styles of agitators. By rapidly moving the cup up and around the agitator, a thorough mixing job can be accomplished. Some combinations may take more time depending on additives, product temperature, technique, and desired consistency of finished product. Due to the difference of recipes, your results may also vary.

Programmable Model

The basic settings of the six PRE-SET buttons for the Mix'n Machine Advance Programmable Model are detailed below. These programs, numbered 1 through 6, are blending cycles designed for the most commonly made desserts. Selecting one of the PRE-SET programs will run the machine for a full cycle. The machine will stop by itself when the cycle is complete. A cycle varies in speed and length. Your machine's PRESET options may differ due to program revisions or if your machine was programmed specifically for your business.

DIAL SETTING	DESSERT TYPE	DESCRIPTION	RUN TIME
1	Easy-to-blend frozen dessert with whole mix-in candies, cookies, etc.	Starts LOW (17%), ramps to MED-HIGH (60%) for 10 seconds, then ramps to HIGH (100%) for 4 seconds	:16
2	Easy-to-blend frozen dessert with chunks of candies, cookies, etc. mixed throughout	Quickly ramps up to HIGH (100%), decreases to MED-HIGH (67%) for 5 seconds, then decreases to MED-LOW (36%)	:16
3	Frozen dessert with syrups that require extended blending time (i.e., thick milkshakes and malts)	Runs on LOW (20%)	:20
4	Hard-to-blend frozen dessert with syrups or mix-ins that require little blending time	Starts LOW (17%) and quickly ramps to HIGH (100%) for 12 seconds	:14
5	Hard-to-blend frozen dessert with whole mix-in candies, cookies, etc.	Ramps up to HIGH (84%) for 10 seconds, then ramps to HIGH (100%) for 6 seconds	:16
6	Hard-to-blend frozen dessert with chunks of candies, cookies, etc. mixed throughout	Starts MED (40%) and quickly ramps to HIGH (100%) for 16 seconds	:20

Note: A 3-second delay is added to the end of each program's run time to allow time for the operator to remove the cup from the agitator before a new program is selected.

Mix'n Machine Blending Procedures

- Put product (ice cream, yogurt, etc.) into a sturdy serving cup along with ingredients such as liquid flavoring, and mix-ins such as candy, cookies, fruit or other condiments.
- For units with a Removable Agitator:** push the agitator up onto the shaft until it snaps into place.
- Plug the machine into the nearest outlet (if unplugged).
- Place a cup guard on the cup (See Figure 1). Hold the cup (and lid or collar) securely in your hand (from the side, not from the bottom) and reach under the splash guard. Move the cup under the agitator and lift up so the agitator touches the bottom of the cup. See Figure 2.
- Turn the machine ON to activate the agitator. Follow instructions based on the specific model:
 - For Mix'n Machine Advance Programmable Model:** Press the ON/OFF power switch to ON. Activate a program by selecting the desired setting on the dial. While holding the cup securely in your hand, use your fingers to push the START Actuator (located behind the agitator) to activate a programmed blending cycle. See Figure 3.
 - For Mix'n Machine Advance Timer Model:** Press the ON/OFF power switch to ON. While holding the cup securely in your hand, use your fingers to push the START Actuator (located behind the agitator) to activate a pre-set timed blending cycle. See Figure 3.
 - For Mix'n Machine Advance Variable Speed Model:** Select the desired setting on the SPEED dial. While holding the cup securely in one hand, use the other hand to press the ON/OFF power switch to ON to activate the agitator. Depending on ingredients, start on a lower setting, then switch to a higher setting once the mixture begins processing.
 - For Mix'n Machine Standard Model (Countertop and Wall Mount):** While holding the cup securely in one hand, use the other hand to press the ON/OFF power switch to ON to activate the agitator.
- With a swirling motion, gradually move the cup up and down around the spinning agitator and completely around all sides of the cup. (If ice cream is hard, this should be done slowly.) Develop your own technique for the desired consistency of the finished product. The agitator will do some chipping and breaking of the solids. However, it is not intended to completely pulverize ingredients as solid chunks are expected to be evident in the final product. See Figure 4.

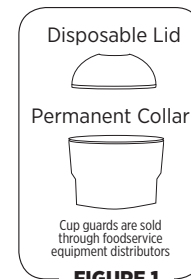

FIGURE 1



FIGURE 2

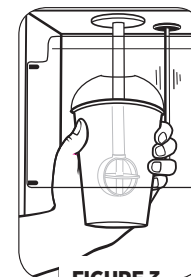

FIGURE 3



FIGURE 4

GENERAL INSTRUCTIONS

Notes: Should the cup be hard to hold, either move the agitator into the mix more slowly or start with softer ice cream. Do not continue to operate if you are having trouble holding the cup.

Both the permanent agitator and the removable agitator are designed to reduce the possibility of damage when contacting a paper cup. However, they should not be forced or held solidly against the side or bottom of the cup. The hard ice cream agitator is specially designed to mix the product aggressively and thoroughly, so use of a cup holder or sturdy cup is recommended to prevent the agitator from going through the side of the cup.

7. Swirl the cup around the agitator to produce a pleasing product appearance and to avoid leaving a hole in the center of the mixture. Before removing the cup, allow excess mixture to be thrown off the agitator and be caught by the cup or lid/collar. Follow machine shut-off instructions based on the specific model:

• **For Mix'n Machine Advance Programmable Model:**

The machine will shut off automatically at the end of the programmed cycle. When the program is within 4 seconds of completion, the LED Indicator light will blink so preparation can begin to remove the cup from the agitator. The blinking light will get progressively faster to indicate that the program cycle is almost complete and the machine will shut off. This provides an indication, so that excess product can be spun off the agitator. See Figure 5.

• **For Mix'n Machine Advance Timer Model:** The machine will shut off automatically at the end of the preset time. When the program is within 4 seconds of completion, the LED Indicator light will blink so preparation can begin to remove the cup from the agitator. The blinking light will get progressively faster to indicate that the program cycle is almost complete and the machine will shut off. This provides an indication, so that excess product can be spun off the agitator. See Figure 5.

• **For Mix'n Machine Advance Variable Speed Model:**

Press ON/OFF power switch to OFF to stop the machine. See Figure 6.

• **For Mix'n Machine Standard Model (Countertop and Wall Mount):** Press ON/OFF power switch to OFF to stop the machine. See Figure 6.

8. Press the ON/OFF switch to OFF when not in use.

• **To use the PULSE switch to refresh drinks and desserts (Advance Programmable Model only):**

Make sure the power is ON. Move the cup under the agitator and lift up so the agitator touches the bottom of the cup. Depress the PULSE switch to start the agitator. With a swirling motion, gradually move the cup up and down over the spinning agitator and completely around all sides of the cup. Swirl the cup around the agitator to produce a pleasing product appearance and to avoid leaving a hole in the center of the mixture. Before removing the cup, allow excess mixture to be thrown off the agitator and be caught by the cup or lid/collar. Release the switch to stop the agitator.

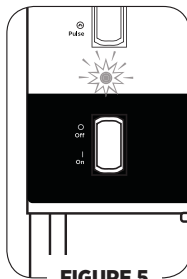

FIGURE 5

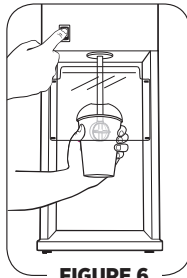

FIGURE 6

PROGRAMMING

The Mix'n Machine Advance Programmable Model is pre-programmed with six blending options. The Mix'n Machine Advance Timer Model is pre programmed with one pre-set timed blending cycle. The programs can be customized by using a programming chip or programmer software kit available from Vita-Mix Corporation. Call your distributor or Customer Service for more information.

Although your machine comes from the factory pre-set with program(s), follow these instructions when using a custom programming chip.

Programming with a Custom Chip

1. Turn the power to the machine ON using the ON/OFF switch located on the front of the machine.
2. Facing the front of the machine, locate the programming port on the right side panel. Insert the custom programmed chip with the silver contact bars up.
3. Within 5 seconds, the six PRE-SET PROGRAMS will be re-programmed. The LED Indicator light on the front of the machine will blink when the program is accepted. If the LED light does not blink, remove the programmed chip and see note below.
4. Remove the programming chip, return it to the original package and store in a safe, easily accessible spot.

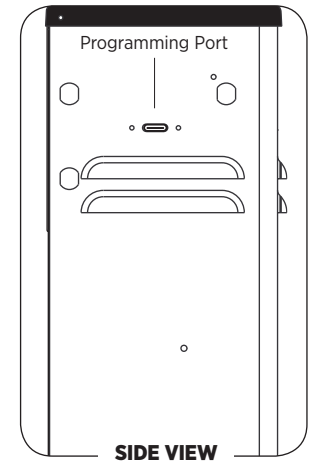

Resetting the Pre-Set Programs to the Original Factory Settings

1. Turn the power to the machine OFF using the ON/OFF switch located on the front of the machine.
2. Hold down the PULSE button while turning the power back ON using the ON/OFF switch.

IMPORTANT NOTES!

PROGRAMMING CHIP: If the above programming steps are taken and the LED light does not blink or the custom programming does not appear with the first blend cycle, turn the chip 180° (side-to-side) and try again.

AGITATORS



CAUTION!

SHOCK HAZARD. Unplug the machine before making any adjustments to the Agitator Shaft.

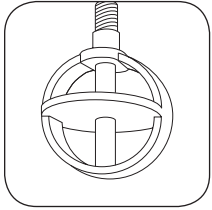

Permanent Soft Ice Cream Agitator: Made of durable NSF accepted Acetal, this non-metal agitator can be pushed up against the inside of paper or plastic cups with no damage to the cup.

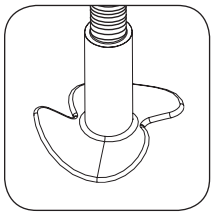

Aggressive/Permanent Hard Ice Cream Agitator: The rounded fins of this specially designed NSF accepted stainless steel agitator efficiently and aggressively mix hard ice cream product at 5°F / -15°C scooping temperature. Use of a sturdy cup (i.e., durable paper or plastic, metal) is recommended.

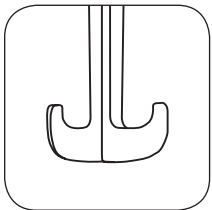

Removable/Reusable Agitator: Made of durable NSF accepted Acetal, this rigid removable and reusable agitator cleans easily and is ideal for preventing flavors, colorings and potential allergens from being transferred from serving to serving.

IMPORTANT NOTES!

See pages 17 or 19 for kit options for converting from either of the Permanent Agitators to a Removable Agitator or from a Removable Agitator to either of the Permanent Agitators.

SPLASH GUARD

Because of their unique designs, the splash guards catch the product thrown from the agitator and shield the operator during mixing.

On the countertop units, the splash guard pivots up and down to prevent thin drinks or desserts from splashing the operator. On the wall mount units, the splash guard slides up and down riding on top of either a removable or disposable cup guard. It will not restrict the circular and up and down motion required for fast, efficient mixing.

Both splash guards remove easily for cleaning. See page 14 for details.

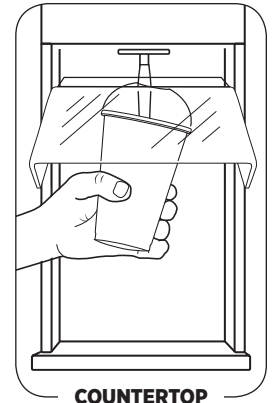

COUNTERTOP

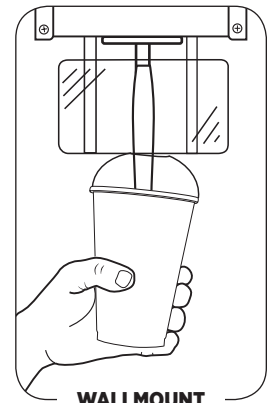

WALLMOUNT

CARING FOR YOUR MACHINE

Permanent Agitators

1. Fill a durable square or rectangular container to within 1 in. / 3 cm from the top with hot (110°F / 43°C) water containing mild liquid detergent (1 oz. per qt. / 30 ml per Ltr.). The container must be deep enough to submerge the entire agitator and the shaft.
2. Hold the container up around the agitator and shaft, all the way up to the bottom of the motor chamber, and turn the machine on. Run for about 15 seconds. Repeat several times. Make sure all portions of the shaft which contact food have been submerged. (Moving Splash Guard must be removed for this cleaning operation.)
3. Repeat step 2, except use rinse water.
4. Repeat step 2, except use an approved 100 ppm sanitizing solution and cleaner and run agitator and shaft under solution for a minimum of two minutes.
5. Resanitize at the start of the day.

Removable/Reusable Agitator

1. Remove agitator from machine. Wash in warm soapy water.
2. Rinse clean.
3. Sanitize as necessary.
4. Dry and reassemble. NOT recommended for dishwasher. Excessive commercial dishwasher heat may slightly bend the removable agitator which could cause unbalance when blending.

Housing

1. Unplug the machine.
2. Remove the Splash Guard and wash in warm soapy water. Rinse clean and sanitize as necessary. Do not use any abrasive material or paper towels which would scratch the surface. Also avoid cleaners which contain ammonia (most window cleaners contain ammonia). NOT recommended for dishwashers.

Countertop Models only: To remove the Splash Guard, squeeze the sides until clear of the top pivot pins and pull the guard out. To mount the Splash Guard, squeeze the sides and place onto the top pivot pins. The guard should sit on the bottom pivot pins.

Wall Mount Models only: To remove the moving Splash Guard, squeeze the travel rods together and slide the guard down. To mount the moving Splash Guard, slide the Splash Guard up over the rods until they snap in place. To clean the travel rods, wipe with a damp cloth. Do not remove the rods from the mixer.

3. All stainless steel surfaces may be cleaned and disinfected with a commercial cleaning solution. However, do not spray any water or other fluids into the motor chamber. Do not use excess liquid around the switches, motor protector, or cord entry hole. Abrasive cleaners may leave noticeable changes in the surface finish. Make sure all areas in and around the motor enclosure and machine are dry before plugging the machine back in.
4. Switches may become sticky from use. Unplug the machine and use a damp cloth, moistened with water and a mild detergent, to clean around the edges of the switch paddles until they function freely. Work the switches back and forth a few times to loosen any dried residue under switch. Leaving switches sticky will damage or burn out the switches. Clean carefully, using caution not to allow water or other liquids to infiltrate the switch. Dry with a soft cotton cloth. Make sure switches are dry before plugging the machine back in.

IMPORTANT NOTES!

CLEANING AND SANITIZING PRODUCTS:

- Do not use abrasive cleaning agents or concentrated bleach when cleaning.
- Do not use any cleaners containing Quaternary Sanitizers on polycarbonate components.
- Follow cleaner/sanitizer manufacturer's specifications and instructions.
- Local codes should be followed for cleaning/sanitizing equipment.

PARTS LIST

Mix'n Machine Advance and Mix'n Machine Standard Countertop Models

- #30019 Permanent Soft Ice Cream Agitator
- #30019 Removable/Reusable Agitator (10 pack)
- #30018 Aggressive/Permanent Hard Ice Cream Agitator
- #30023 Agitator Shaft – for countertop models
- #30015 Splash Guard – for countertop models

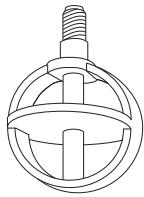

#30019

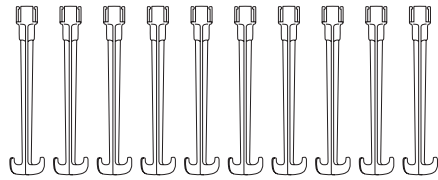

#30003

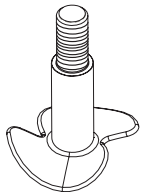

#30018

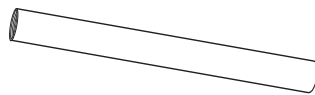

#30023

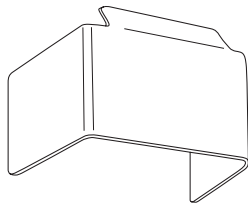

#30015

Kits Sold Separately:

- #80 Conversion Kit (Permanent Soft/Hard Ice Cream Agitator To Removable/Reusable Agitator)
- #81 Conversion Kit (Removable/Reusable Agitator To Permanent Soft Ice Cream Agitator)
- #30006 Conversion Kit (Removable/Reusable Agitator To Aggressive Permanent Hard Ice Cream Agitator)
- #15668 Wall and Counter Sure-Support Mounting Kit – for countertop models only
- #1240 Replacement Feet (4 pack)
- #30000 Guarded Air-Activated Foot Control – for 120V Advance Variable Speed and Standard models
- #30002 Guarded Air-Activated Foot Control – for 220-240V Advance Variable Speed and Standard models



#80

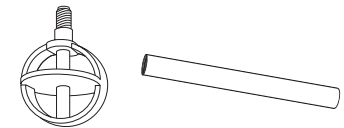

#81

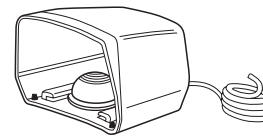

#30000 & 30002

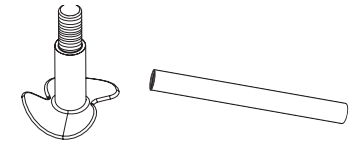

#30006

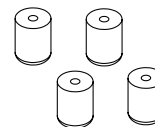

#1240

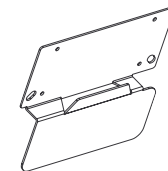

#15668

PARTS LIST

Mix'n Machine Standard Wall Mount Model

- #30019 Permanent Soft Ice Cream Agitator
- #30003 Removable/Reusable Agitator (10 pack)
- #30018 Aggressive/Permanent Hard Ice Cream Agitator
- #30034 Agitator Shaft – for wall mount models
- #30029 Splash Guard – for wall mount models

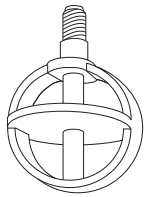

#30019

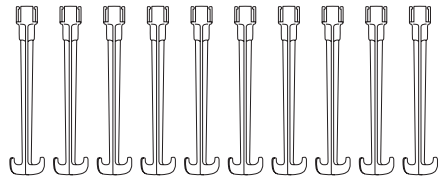

#30003

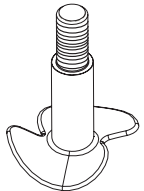

#30018

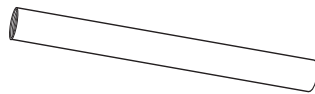

#30023

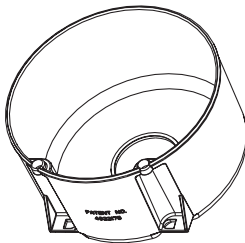

#30029

Kits Sold Separately:

- #80 Conversion Kit (Permanent Soft/Hard Ice Cream Agitator To Removable/Reusable Agitator)
- #30004 Conversion Kit (Removable/Reusable Agitator To Permanent Soft Ice Cream Agitator)
- #30005 Conversion Kit – must be used with #30034 – sold separately (Removable/Reusable Agitator To Aggressive/Permanent Hard Ice Cream Agitator)
- #30000 Guarded Air-Activated Foot Control – for 120V model
- #30002 Guarded Air-Activated Foot Control – for 220-240V model
- #1234 Stand-off Mounting Kit – for wall mount models only
- #1245 Drip Tray Kit – for wall mount models only



#80

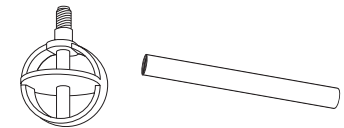

#81

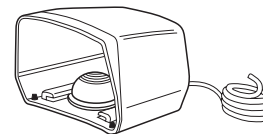

#30000 & 30002



#30006

Note: Must be used with #30034 – Sold separately

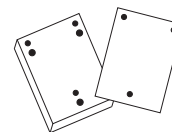

#1234



#1245

TROUBLESHOOTING

Problems:

- Machine will not run
- Machine will not run when START Actuator or ON/OFF power switch is activated

Possible Actions:

- Double-check to make sure power cord is firmly plugged into power outlet and that you have power to the outlet.
- Check ON/OFF power switch to make sure the switch is in the ON position.
- Check to make sure switches are clean and moving freely.
- Check the reset breaker to see if it has tripped. See page 21.

- Machine is running irregularly
- Setting selected starts the wrong program

- Reset the machine to its original factory settings or reprogram with a custom programming chip. See page 11.
- Try plugging machine into a new outlet.

Problem:

- Loose or misaligned shaft
- Vibration noise

Possible Actions:

- Unplug the machine.
- Make sure the shaft extension is threaded tight onto the motor shaft with the slinger centered and square.
- To tighten a loose shaft, remove the cap and hold the motor shaft with a screwdriver in the slot on the top end. Turn the agitator with your hand until tight. If tools must be used to hold the shaft extension, be sure to protect it from being scratched as that would reduce its cleanability.
- If the shaft is still misaligned, rotate the shaft by hand while holding a marking pen close to the lower end. The first spot to touch and leave a mark is the side of the shaft most out of alignment. Lay the machine on its back (remove the plastic agitator to avoid breakage) and gently tap the marked side of the shaft with a rubber mallet. Repeat the process until the marking pen leaves a mark most of the way around the shaft and the unit runs smooth. Regulate your mallet taps to move the shaft towards the center without overshooting.

If you cannot fix your machine, call Vitamix Technical Support at (800) 866.5235. If outside the United States and Canada, contact your local Vitamix Distributor or telephone the Vitamix International Division at +1 (440) 782.2450 or email international@vitamix.com for a distributor in your country.

MOTOR PROTECTION

The Mix'n Machine is equipped with a reset breaker mounted on the motor enclosure. See Figures 1 and 2. Should the motor be kept from turning (locked rotor) or otherwise be overloaded, the breaker will trip. If this occurs, make sure the motor is free to rotate and wait a short period for it to cool down before pushing the reset breaker and restarting the motor. Never remove or bypass the reset breaker.

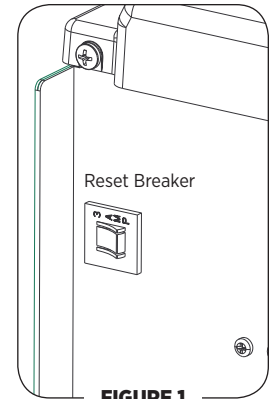

FIGURE 1
Countertop Machine (Side View)

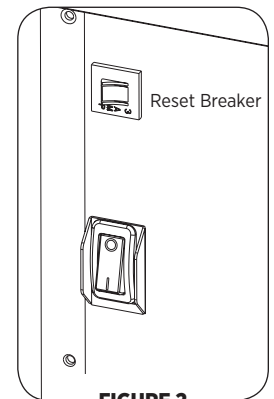

FIGURE 2
Wallmount Machine (Front View)

WARRANTY

LIMITED WARRANTY *(Unless otherwise covered by Contract)*

Vita-Mix® Corporation (hereinafter “Vitamix”) warrants to the original end-user (“Purchaser”) that its commercial equipment, including the Mix’n Machine and Mix’n Machine Advance (the “Equipment”) will be free from defects in material and workmanship as described herein and subject to the conditions set forth below. Proof of purchase is required.

The following are the sole remedies of the Purchaser and set forth the only warranty obligations of Vitamix.

No employee of Vitamix or any other person is authorized to make any warranty in addition to or amendment of the following warranties.

WHAT IS COVERED UNDER WARRANTY

Vitamix warrants to the original end-user that:

- If the Equipment fails due to defects in material or workmanship within the period described below then Vitamix will assume the cost of all parts and labor necessary to repair the Equipment:
- Mix’n Machine and Mix’n Machine Advance. Three (3) Years from the date of purchase for Non-Consumable Parts, and Ninety (90) days on Consumable Parts that include the splash guard, mixing agitator or agitator drive shaft extension, actuator switch rod or switch rod seal, and foot control.
- Automatic Mix’n Machine. Two (2) Years from the date of purchase on Non-Consumable Parts and Ninety (90) days on Consumable Parts. Consumable Parts are defined as the cup holder, cup holder boot, cup holder seal and front door assembly. All other parts are Non-Consumable parts.
- There is no warranty with respect to the mixing agitator or spoon, which may be supplied with the Equipment

The sole obligation of Vitamix under these warranties is to repair or replace the warranted part or parts as determined exclusively by Vitamix.

IN NO EVENT, WHETHER BASED ON CONTRACT, INDEMNITY, WARRANTY, TORT (INCLUDING NEGLIGENCE), STRICT LIABILITY OR OTHERWISE, SHALL VITAMIX BE LIABLE FOR ANY SPECIAL, INDIRECT, INCIDENTAL OR CONSEQUENTIAL DAMAGES WHATSOEVER INCLUDING, WITHOUT LIMITATION, LOSS OF PROFIT OR REVENUE. THE ABOVE LIMITED WARRANTY IS YOUR EXCLUSIVE REMEDY, AND YOU AND VITAMIX HEREBY EXPRESSLY DISCLAIM ALL OTHER WARRANTIES OR CONDITIONS, EXPRESS OR IMPLIED, STATUTORY OR OTHERWISE, INCLUDING ANY IMPLIED WARRANTY OF MERCHANTABILITY AND ANY IMPLIED WARRANTY OF FITNESS FOR A PARTICULAR PURPOSE, AND, WITHOUT LIMITING THE GENERALITY OF THE FOREGOING, YOU AND VITAMIX HEREBY EXPRESSLY EXCLUDE, TO THE EXTENT PERMITTED BY LAW, THE APPLICATION OF ANY SALE OF GOODS LEGISLATION AND THE UNITED NATIONS CONVENTION ON CONTRACTS FOR THE INTERNATIONAL SALE OF GOODS, AS MAY BE APPLICABLE.

Some jurisdictions do not allow a limitation on implied warranties or on special, incidental or consequential damages.

WHAT IS NOT COVERED UNDER WARRANTY *(Coverage Exclusions)*

There is no warranty with respect to the following, which may be supplied with the Equipment: Mixing Agitator or Spoon.

These warranties further exclude distortion, wear or breakage of the splash guard, mixing agitator or agitator drive shaft extension, actuator switch rod or switch rod seal, and damage to the foot control caused by water or other contaminants.

These warranties do not include repairs needed due to:

- A. Normal wear-and-tear;
- B. Abuse, misuse, negligent use;
- C. Alteration of the Equipment;
- D. Exposure to extreme conditions; or
- E. Improper installation of the Equipment, including but not limited to poor workmanship, not following specifications provided.

WHEN DO THE WARRANTIES APPLY *(Coverage Conditions)*

The warranties contained herein run only to the original end-user and are not transferable. To make a warranty claim, proof of purchase is required.

Any warranty offered by Vitamix is only valid if used in accordance with: a) the owner’s manual that may also be accessed at vitamix.com; b) the express warranty; and c) any and all maintenance instructions regardless of when they are supplied.

WHAT CAUSES THE WARRANTY TO BE VOID

All product warranties are void if:

- Any component of a covered piece of Equipment has been modified, altered, “reconditioned” or repaired by persons someone other than Vitamix, an authorized Vitamix Service Center or an authorized Vitamix Distributor.
- Any covered Vitamix Equipment is used with a component not expressly authorized in writing by Vitamix.
- Any Equipment is improperly installed, including but not limited to poor workmanship, not following specifications provided.

LIMITED WARRANTY continues on page 24 ►

WARRANTY

HOW TO OBTAIN WARRANTY COVERAGE AND REPAIR

Who to Contact For Warranty Service and Repair: In the event your Vitamix blender needs service or repair covered by the terms of this warranty, please call Vita-Mix Corporation, an authorized service center or a local distributor for warranty assistance.

- **For Equipment purchased and located in the U.S.A.:**
Call Vitamix Technical Support: (800) 866.5235.
- **For Equipment purchased outside the continental U.S.A.:**
Contact your authorized Vitamix Distributor or the Vitamix International Division at +1 (440) 782.2450 or email international@vitamix.com for a distributor near you.

You will be asked to provide proof of purchase for the Equipment. If the remote technical support team cannot fix the Equipment remotely, the Equipment will need to be serviced. The team will help you either locate an authorized service center or arrange for the Equipment to be shipped back to Vitamix.

HOW TO SHIP THE EQUIPMENT FOR SERVICE

A. Obtain a Return Authorization Number Before Shipment. Do not return or send in Equipment without the approval from Vitamix. Under no circumstances will Vitamix be responsible for the cost of any unauthorized repairs. All Equipment returns must have the Return Authorization Number ("RA") clearly marked on the outside of the box. Any Equipment that is sent to Vitamix without prior authorization or approval will be returned to the shipper's address "as is" without repair. The customer pays for the shipment to Vitamix.

B. Shipping Equipment For Repair In the United States. During the first thirty (30) days, Vitamix will pay standard ground freight to return Equipment subject to this warranty to Vitamix. After the first thirty (30) days, Purchaser will pay the shipping costs to return Equipment covered by this warranty to Vitamix or the local authorized service provider. Vitamix will pay shipping costs to return the merchandise to the location where the Equipment was used. Purchaser will have the option to request expedited freight using the Purchaser's credit card to pay for all applicable shipping expenses. Vitamix will credit the Purchaser's account for the amount of the standard ground freight shipping expense.

SPECIFICATIONS

Dimensions:

COUNTERTOP MODELS:

Machine dimensions: 24 in. / 60.9 cm High x 10 in. / 25.4 cm Wide x 8.25 in. / 20.9 cm Deep

Case dimensions: 27 in. / 68.6 cm High x 10.2 in. / 25.9 cm Wide x 12 in. / 30.5 cm Deep

Shipping weight: Advance Models: 20 lbs. / 9.1 kg; Standard Models: 27 lbs. / 12.2 kg

WALL MOUNT MODELS:

Machine dimensions: 16.5 in. / 41.9 cm High x 7.25 in. / 18.5 cm Wide x 8.75 in. / 22 cm Deep

Case dimensions: 14.4 in. / 36.6 cm High x 10 in. / 25.4 cm Wide x 18.9 in. / 48 cm Deep

Shipping weight: 19 lbs. / 8.6 kg

Motor Speed and Power Requirements:

Advance Models:

500 RPM to 3000 RPM bare motor speed

Volts: 120 VAC / Amps: 2.0 / Hz: 50/60

Volts: 220-240 VAC / Watts: 150-180 / Hz: 50/60

Volts: 100 VAC (Japan) / Watts: 100 / Hz: 50/60

Standard Models:

60 Hz: 3440 RPM bare motor speed; 50 Hz: 2840 RPM bare motor speed

Volts: 120 VAC / Amps: 2.6 / Hz: 50/60

Volts: 220-240 VAC / Watts: 285-325 / Hz: 50/60

Volts: 100 VAC (Japan) / Amps: 2.6 / Hz: 50/60

When applicable:



To see the complete line of Vitamix® products,
visit vitamix.com



Vita-Mix® Corporation Commercial Division

8615 Usher Road, Cleveland, Ohio 44138 U.S.A.

Phone: +1 (440) 235.0214 Email: commercial@vitamix.com

©2012 Vita-Mix Corporation. No part of this publication may be reproduced or transmitted in any form or by any means or stored in a database or retrieval system without the written permission of the Vita-Mix Corporation.

Printed in the U.S.A. XMM001 12/12